

LINKRAN



Linkran Elastomeric Insulation



NACI

LINKRAN

FANTAP®

Producer of Constructional & Industrial materials



SAZEH PAIDAR®

Supplier of Constructional & Industrial materials



■ Company Introduction

FANTAP Co. has been founded in 2018; based on Sazeh Paidar Elahie Group's experience and knowledge, with the aim and policy of domestic production and self-sufficiency in field of construction industry.

The company's production site is located on a field of 13000m² in Shams Abad Industrial Zone and is equipped by the worlds most advanced and up to date devices that enables the production of world-class high-quality products.

On the path of national missions accomplishment and by trusting God, believing in abilities and will power; FANTAP Co. has proceed both the technology transition into the country and the production of installation and support system by the brand name of LINKRAN as one of the pioneers of building installation in supplying different types of installation materials including installation support systems, thermal and sound insulations, fire stop, smoke tight and flexible connections; and beside the gained trust and credibility in business over the years, by studying and supplying the needed resources and products for the production cycle, the company has established itself as the major domestic producers in the industry which led to the staff's experimentation and confidence in the prosperity of national production.

With the prospect of a boom in production and national economy growth, the company has always set valuable goals such as increasing employment of Iranian youth, producing high quality products correspond with the world standards and compete with similar foreign products aiming the price stability, respect for consumer rights and customer orientation and has put all in forefront of its path.



Elastomeric insulation

Elastomeric Insulation is a type of thermal and sound insulation that its structure is closed-cell and is a proper choice for insulating the pipes, ducts, air conditioning systems, installation equipment and etc. Applying this type of insulation possess lots of benefits such as energy consuming optimization, due to proper heat transfer coefficient, keep pipe from rust and corrosion, ease of installation and its flexibility, adhesiveness and paintable ability, prevent of condensation and etc.

Table of Elastomeric insulation comparison with traditional insulation

Technical Data	Elastomeric Foam	Glass Wool	Rock Wool	Polyurethane
Thermal Conductivity ratio in 0°(w/m.k)	0.032 – 0.036	0.041	0.039	0.032 – 0.036
Water Vapor diffusion resistance	$\mu \geq 10,000$	$\mu \geq 1$	$\mu \geq 1$	$\mu \geq 2,000$
Energy saving percentage	70%~94%	Max.45%	Max.50%	70%~94%
Reaction to fire	Slow burner & Self-extinguishing	Non-flammable	Non-flammable	Highly flammable
Risk of corrosion under insulation	No corrosion	Severe corrosion	Moderate corrosion	Low corrosion

Comparing table of Elastomeric insulation (NBR & EPDM)

Physical properties	NBR	EPDM
Material	Nitrile Butadiene Rubber	Ethylene Propylene Diene Monomer
Nominal hardness (IRHD)	60(5±)	60(5±)
Color	Black	Black with yellow spot
Tensile strength	$\geq 10 \text{ N/mm}^2$	$\geq 10 \text{ N/mm}^2$
Tensile strength to tearing	$\geq 300\%$	$\geq 300\%$
Operational temperature application range	Structural, Semi-Industrial	Industrial
Abrasion resistance	Medium to good	Medium to good
Resistance to mineral oils	Very well	Poor
Resistance to herbal oils	Very well	Medium to good
Resistance to gasoline	Very well	Poor
Resistance to aromatic and hydrocarbon compounds	Medium to good	Poor
Resistance to acids and bases	Very well	Very well
Resistance against fire	Medium to good	Medium to good
Resistance to moisture / Steam	Very well	Very well
Resistance to sunlight and UV	Medium to good	Very well
Thermal resistance	Very well	Very well



Self-extinguishing against fire



Clean technology and eco environmental



Time saving in installation and ease in implement

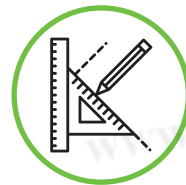

Precise engineering and analysis



Energy saving



Non-use of toxics and allergens



Increase system performance and productivity



Significant durability and shelf life



Very low water vapor absorption and diffusion



Reduce cost in system maintenance operation

Elastomeric roll insulation

Thermal insulation

This type of insulation is used in insulating different surfaces such as HVAC air duct, tanks, installation equipment's walls, big size steel pipes, interior and exterior of building and etc. LINKRAN thermal insulations produce in a variety of simple, self-adhesive, with protect black or Aluminum covering. The LINKRAN Elastomeric insulation adhesive can be used in order to stick and install these insulations.

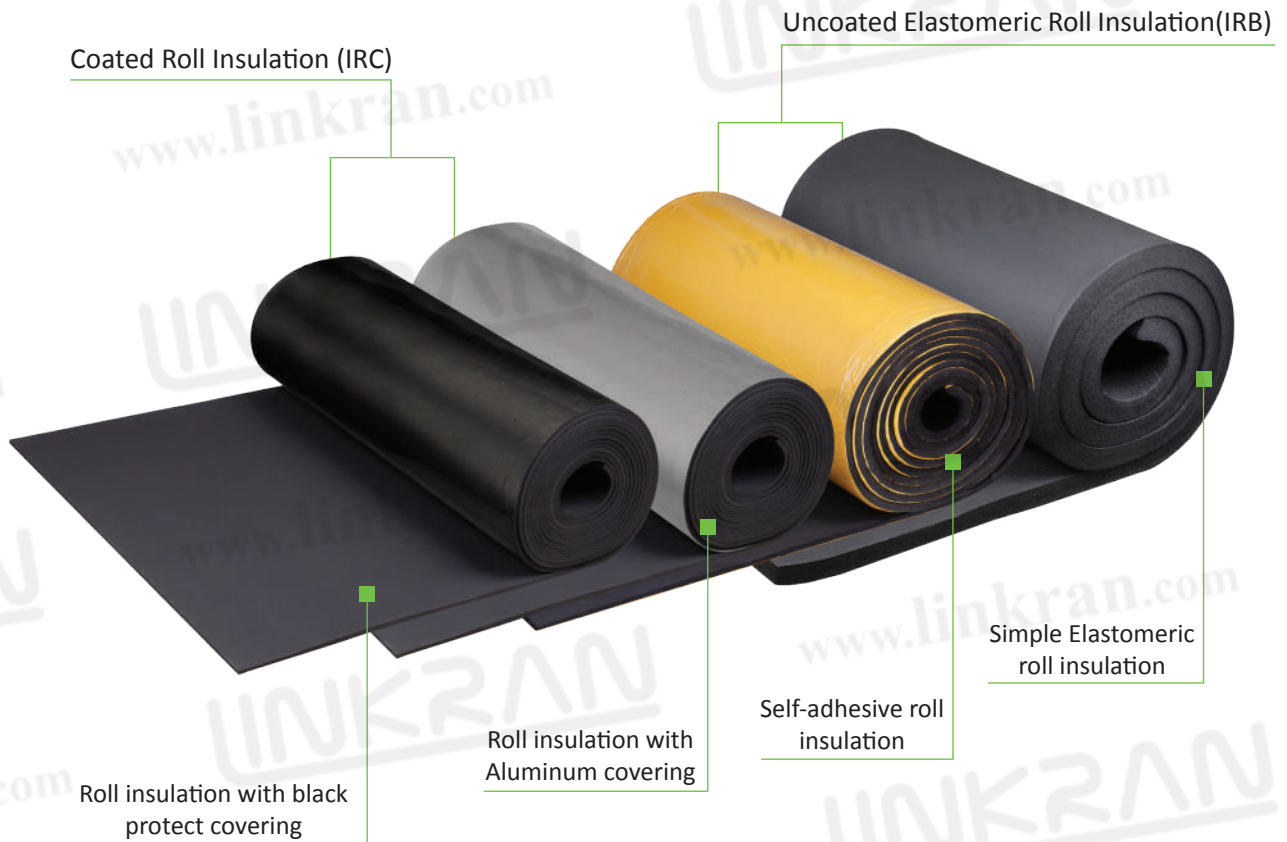

Sound insulation

This type of insulation is used for controlling and absorbing sound waves. LINKRAN elastomeric sound insulations are produced in simple shape and wavy shape. Regarding to the sound source frequency, the sound absorption function in these insulations is different.

Simple Sound Insulation (IRS)



Wavy Shape Sound Insulation (IRW)

■ Tubular thermal insulation

■ Thermal insulation

This type of insulation is applied for insulating variety types of pipes with different usage and materials, such as hot water pipes, fan coil pipes, HVAC systems and other installation equipment. LINKRAN pipe insulations are produced in four forms: simple, aluminum coated, Protect black and pre-slit



Uncoated Elastomeric Roll Insulation(IRB)

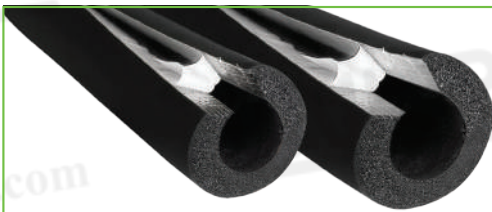

Pre-slit self-adhesive tubular insulation



Simple tubular insulation

Coated Tubular Insulation (ITC)

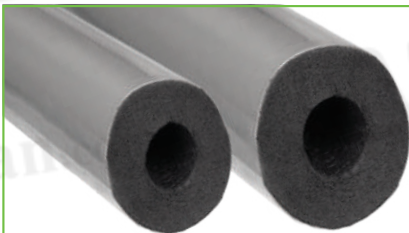

Tubular thermal insulation with Aluminum covering



Tubular thermal insulation with protect black

■ Elastomeric sheet insulation

■ Elastomeric sound insulation (ISE)

This type of insulation is applied as sound insulation with high sound absorption performance in walls, ceilings, floors, pipe lines, HVAC systems and other installation equipment. LINKRAN sheet insulations have a higher durability and strength than other structural insulations due to its high mechanical strength, so it can be used in construction substrates.



■ Installation accessories

■ Elastomeric insulation liquid adhesive (IGM)

LINKRAN Elastomeric insulation liquid adhesive is used for connecting insulations together or to the different surfaces such as duct surface, pipe, wall and etc. This type of adhesive is designed and produced in such a way that it does not cause corrosion on insulation surface and is in compliance with elastomeric insulation in terms of thermal resistance. LINKRAN Elastomeric insulation adhesive is produced in 1 and 3 Liter cans.



■ Elastomeric rubber foam tape (IRT)

This type of Elastomeric rubber tape is applied in sealing the length of tubular thermal and roll insulations, and end-to-end fittings of Elastomeric insulation. LINKRAN Elastomeric rubber foam tape is produced in different width and thicknesses from the Elastomeric insulation material and in form of self-adhesive.

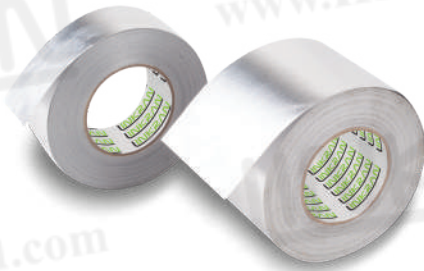

■ Reinforced Aluminum tape (IAT)

Reinforced Aluminum tape is applied in sealing the length of the tubular thermal and roll insulations and covering the end-to-end fittings. LINKRAN reinforced Aluminum tape is also applied in places which the Elastomeric insulation is close to humidity, vapor, oil, direct sunlight and etc. This product is made of reinforced Aluminum and it is self-adhesive.

■ Reinforced Tarpaulin Tape (ITT)

Reinforced tarpaulin tape is applied in sealing the length of tubular thermal and roll insulations and covering the end-to-end fittings. This type of tape is applied in places which the Elastomeric insulation is close to humidity, vapor, oil, direct sunlight, etc. and more tensile strength is needed.



Table of LINKRAN produced insulation

Tubular Thermal Insulation										Rolled Insulation		Sheet insulation	
Inner diameter of Tubular Thermal Insulation (mm)	Tubular Thermal Insulation			Insulation Thickness(mm)						Insulation Thickness (mm)	Roll dimension (m)	Insulation Thickness (mm)	Sheet dimension (m)
	Steel Pipes (inch)	Copper pipes (inch)	Multilayer and polymer pipes (mm)	9	13	16	19	25	32				
				Insulation lenght per carton in terms of insulation thickness (m)									
6	-	1/4	-	352	150	120	100	64	-	6	1x30	13	1x2
8	-	-	-	266	130	110	98	58	-		1.2x30		
10	1/8	3/8	-	266	130	110	98	58	-		1.5x30		
12	-	1/2	-	234	110	100	88	54	-	9	1x20		
15	1/4	5/8	16	192	92	88	78	52	16		1.2x20		
18	3/8	3/4	-	166	88	78	66	50	-	13	1.5x20		
22	1/2	7/8	20	136	84	74	64	42	32		1x14		
25	-	1	25	120	87	60	48	40	36		1.2x14		
28	3/4	1 1/8	-	98	72	60	48	40	24	16	1.5x14	19	1x2
32	-	-	32	80	60	50	36	24	22		1x12		
35	1	1 3/8	-	76	58	50	36	24	22		1.2x12		
42	1 1/4	1 5/8	-	60	48	40	32	22	16	19	1.5x12	25	1x2
48	1 1/2	-	-	50	40	30	24	18	14		1x10		
60	2	-	-	46	32	24	22	12	10	25	1.2x10	32	1x2
76	2 1/2	3	-	40	26	22	18	10	8		1.5x10		
89	3	3 1/2	-	36	24	18	14	8	8		1x8		
114	4	-	-	32	20	14	12	6	6	32	1.2x8	50	1x2
											1.5x8		
										40	1x6	32	1x2
											1.2x6		
										50	1.5x6	32	1x2
											1x4		
										50	1.2x4	32	1x2
											1.5x4		
										50	1x4	32	1x2
											1.2x4		
										1.5x4			

Gallery



LINKRAN Elastomeric Insulation Production Line



LINKRAN Site (Shams Abad Industrial Zone)



LINKRAN Elastomeric Insulation Implemented Samples



LINKRAN Professional Laboratory



LINKRAN's Staff

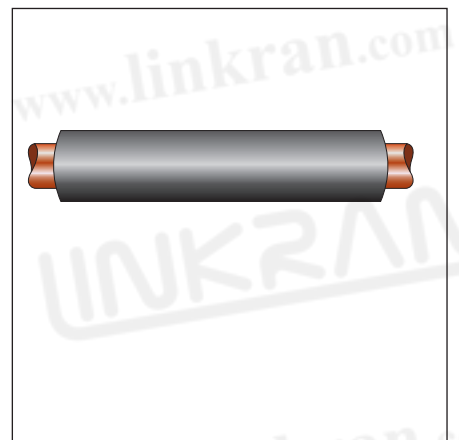
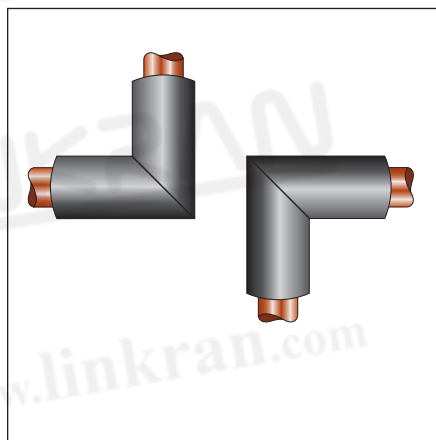
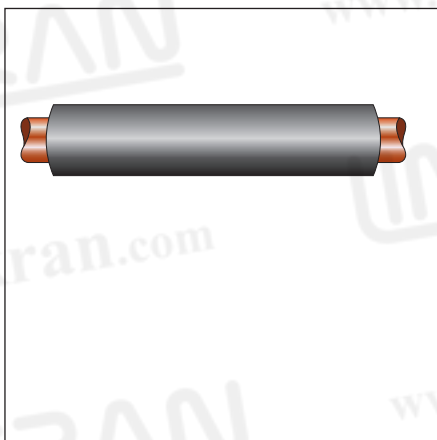
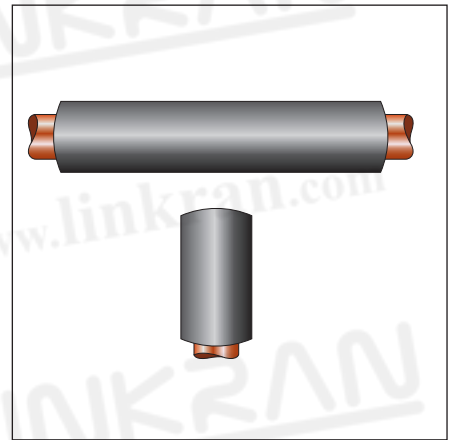
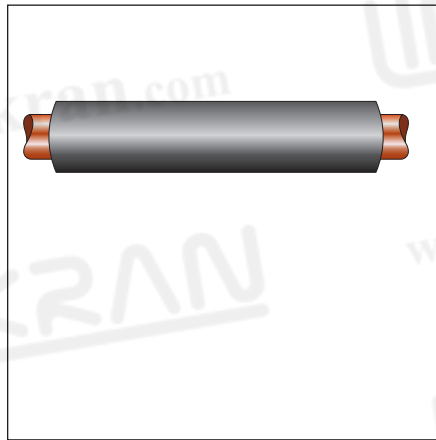
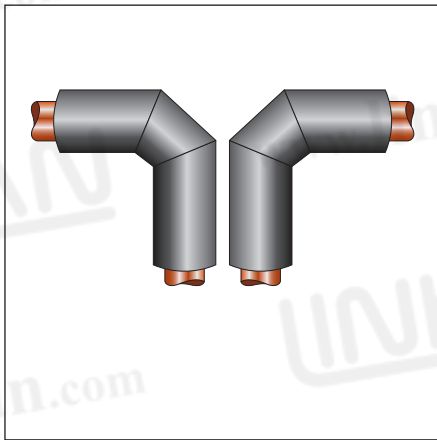
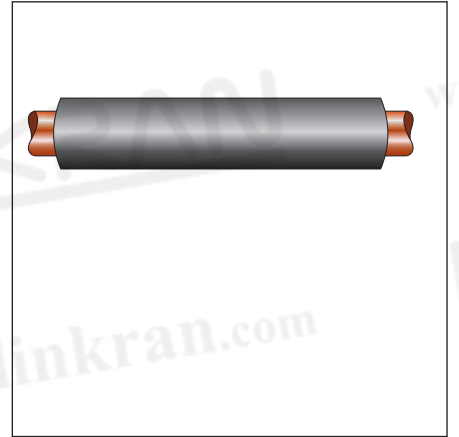
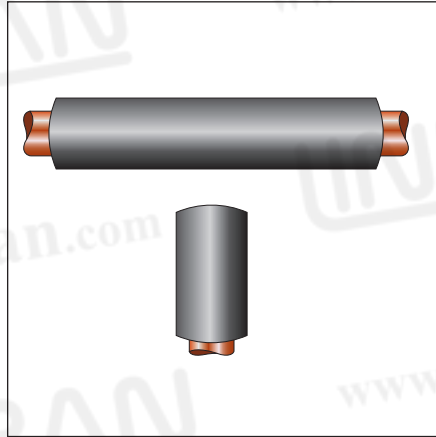
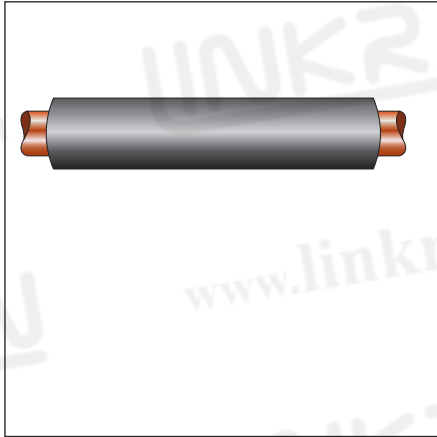

FANTAP

Modern Construction & Industry Materials

No5, Darya Alley, Nazerian Qomi St.,
Kouye Nasr, Tehran, Iran

Tel: (+98 21) 88 28 85 51 -3

Fax: (+98 21) 88 28 8554

www.linkran.com



info@linkran.com



[Linkran_official](#)



LI 20200401